

**DATA SHEET**

# FortiGate® 7121F Series

FG-7121F, FIM-7921F, and FPM-7620F

**Next Generation Firewall  
Segmentation  
IPS  
Mobile Security**

The FortiGate 7121F series delivers high performance next generation firewall (NGFW) capabilities for large enterprises and service providers. With multiple high-speed interfaces, high-port density, and high-throughput, ideal deployments are at the enterprise edge, hybrid data center core, and across internal segments. Leverage industry-leading IPS, SSL inspection, and advanced threat protection to optimize your network's performance. Fortinet's Security-Driven Networking approach provides tight network integration to the new security generation.

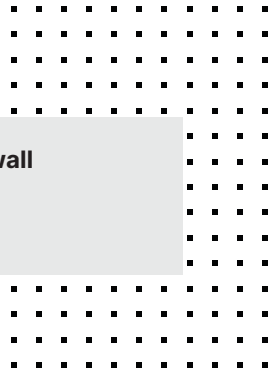
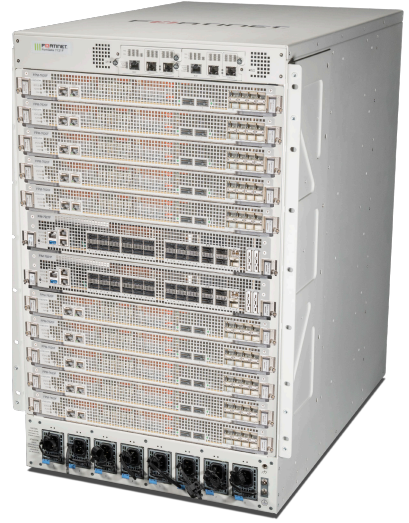

**Security**

- Identifies thousands of applications inside network traffic for deep inspection and granular policy enforcement
- Protects against malware, exploits, and malicious websites in both encrypted and non-encrypted traffic
- Prevent and detect against known and unknown attacks using continuous threat intelligence from AI-powered FortiGuard Labs security services

**Performance**

- Delivers industry's best threat protection performance and ultra-low latency using purpose-built security processor (SPU) technology
- Provides industry-leading performance and protection for SSL encrypted traffic

**Certification**

- Independently tested and validated for best-in-class security effectiveness and performance
- Received unparalleled third-party certifications from NSS Labs

**Networking**

- Delivers advanced networking capabilities that seamlessly integrate with advanced layer 7 security and virtual domains (VDMs) to offer extensive deployment flexibility, multi-tenancy and effective utilization of resources
- Delivers high-density, flexible combination of various high-speed interfaces to enable best TCO for customers for data center and WAN deployments

**Management**

- Includes a management console that is effective, simple to use, and provides comprehensive network automation and visibility
- Provides Zero Touch Integration with Fortinet's Security Fabric Single Pane of Glass Management
- Predefined compliance checklist analyzes the deployment and highlights best practices to improve overall security posture

**Security Fabric**

- Enables Fortinet and Fabric-ready partners' products to provide broader visibility, integrated end-to-end detection, threat intelligence sharing, and automated remediation

FIREWALL	IPS	NGFW	THREAT PROTECTION	NETWORK INTERFACES
<b>1.89 Tbps</b>	<b>675 Gbps</b>	<b>550 Gbps</b>	<b>520 Gbps</b>	25 GE SFP28 / 10 GE SFP+ / GE SFP 100 GE QSFP28 / 40 GE QSFP+ 400 GE QSFP-DD

## DEPLOYMENT



### Next Generation Firewall (NGFW)

- Reduce the complexity and maximize your ROI by integrating threat protection security capabilities into a single high-performance network security appliance, powered by Fortinet's Security Processing Unit (SPU)
- Full visibility into users, devices, applications across the entire attack surface and consistent security policy enforcement irrespective of asset location
- Protect against network exploitable vulnerabilities with Industry-validated IPS security effectiveness, low latency and optimized network performance
- Automatically block threats on decrypted traffic using the Industry's highest SSL inspection performance, including the latest TLS 1.3 standard with mandated ciphers
- Proactively block newly discovered sophisticated attacks in real-time with AI-powered FortiGuard Labs and advanced threat protection services included in the Fortinet Security Fabric



### Segmentation

- Segmentation that adapts to any network topology, delivering end-to-end security from the branch level to data centers and extending to multiple clouds
- Reduce security risks by improving network visibility from the components of the Fortinet Security Fabric, which adapt access permissions to current levels of trust and enforce access control effectively and efficiently
- Delivers defense in depth security powered by high-performance L7 inspection and remediation by Fortinet's SPU, while delivering third party validated TCO of per protected Mbps
- Protects critical business applications and helps implement any compliance requirements without network redesigns



### IPS

- Purpose-built security processors delivering industry validated IPS performance with high throughput and low latency
- Deploy virtual patches at the network level to protect against network exploitable vulnerabilities and optimize network protection time
- Deep packet inspection at wire speeds offers unparalleled threat visibility into network traffic including traffic encrypted with the latest TLS 1.3
- Proactively block newly discovered sophisticated attacks in real-time with advanced threat protection provided by the intelligence services of the Fortinet Security Fabric



### Mobile Security for 4G, 5G, and IOT

- SPU accelerated, high performance CGNAT and IPv4 and IPv6 traffic, for 4G SGI LAN and 5G N6 security
- User plane security enabled by full Threat Protection and visibility into GTP-U inspection
- 4G and 5G security for user and data plane traffic SCTP, GTP-U/C and SIP that provides protection against attacks
- 4G and 5G cores IoT signaling storm protection
- High-speed interfaces to enable deployment flexibility

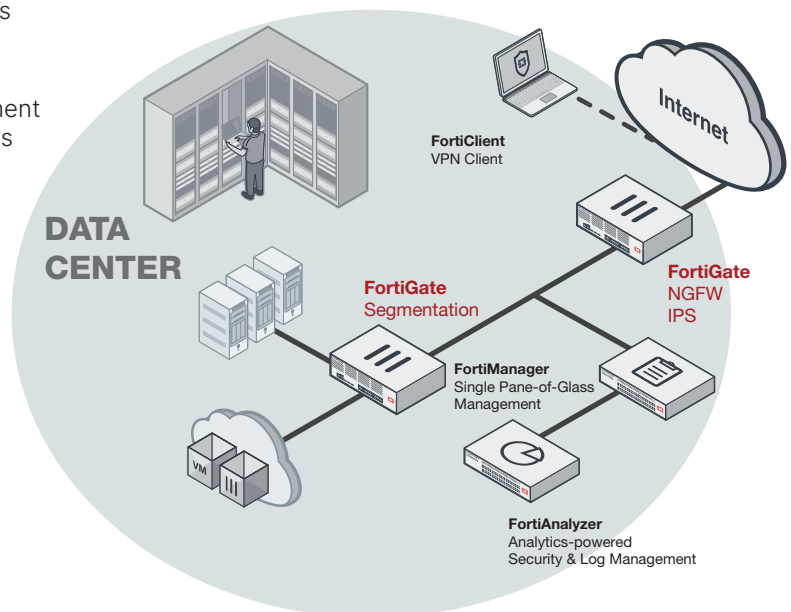

**Data Center Deployment (IPS/NGFW, Intent-based Segmentation)**



# FORTINET SECURITY FABRIC

## Security Fabric

The industry's highest-performing cybersecurity platform, powered by FortiOS, with a rich ecosystem designed to span the extended digital attack surface, delivering fully automated, self-healing network security.

- **Broad:** Coordinated detection and enforcement across the entire digital attack surface and lifecycle with converged networking and security across edges, clouds, endpoints, and users
- **Integrated:** Integrated and unified security, operation, and performance across different technologies, location, deployment options, and the richest ecosystem
- **Automated:** Context aware, self-healing network and security posture leveraging cloud-scale and advanced AI to automatically deliver near-real-time, user-to-application coordinated protection across the Fabric

The Fabric empowers organizations of any size to secure and simplify their hybrid infrastructure on the journey to digital innovation.

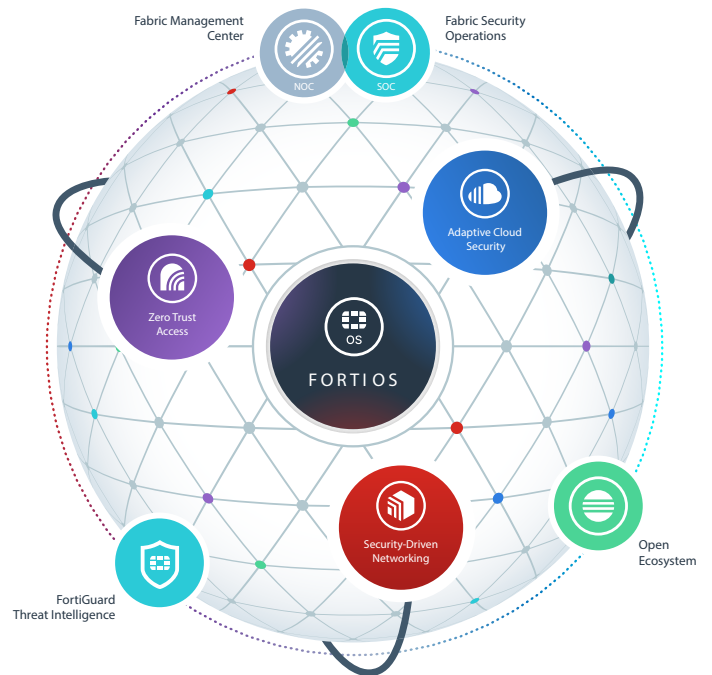

## FortiOS™ Operating System

FortiOS, Fortinet's leading operating system enable the convergence of high performing networking and security across the Fortinet Security Fabric delivering consistent and context-aware security posture across network endpoint, and clouds. The organically built best of breed capabilities and unified approach allows organizations to run their businesses without compromising performance or protection, supports seamless scalability, and simplifies innovation consumption.

The release of FortiOS 7 dramatically expands the Fortinet Security Fabric's ability to deliver consistent security across hybrid deployment models of Hardware, Software, and Software As-a-Service with SASE and ZTNA, among others.

## SERVICES

### FortiGuard™ Security Services

FortiGuard Labs offer real-time intelligence on the threat landscape, delivering comprehensive security updates across the full range of Fortinet's solutions. Comprised of security threat researchers, engineers, and forensic specialists, the team collaborates with the world's leading threat monitoring organizations and other network and security vendors, as well as law enforcement agencies.

### FortiCare™ Services

Fortinet is dedicated to helping our customers succeed, and every year FortiCare services help thousands of organizations get the most from their Fortinet Security Fabric solution. We have more than 1,000 experts to help accelerate technology implementation, provide reliable assistance through advanced support, and offer proactive care to maximize security and performance of Fortinet deployments.



# HARDWARE

## FortiGate 7121F

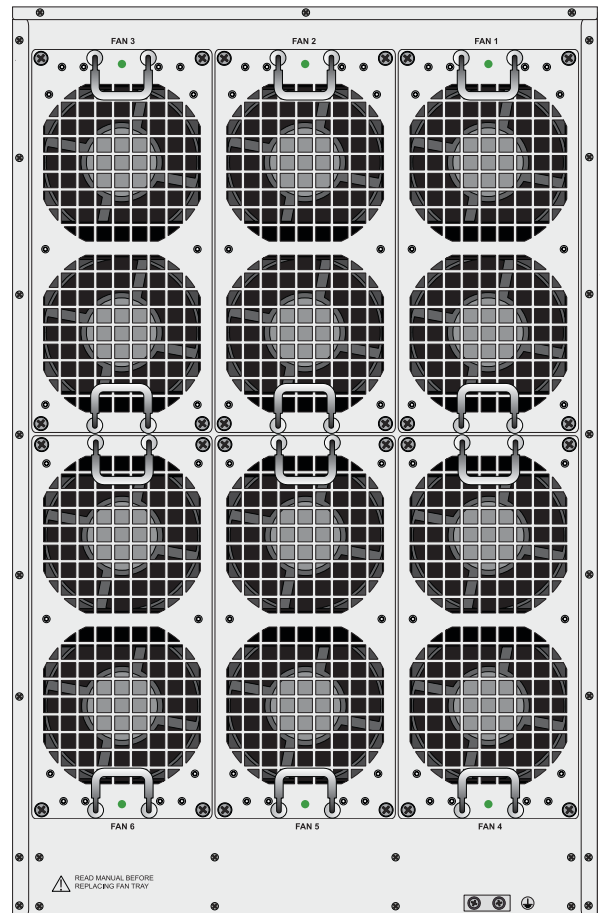
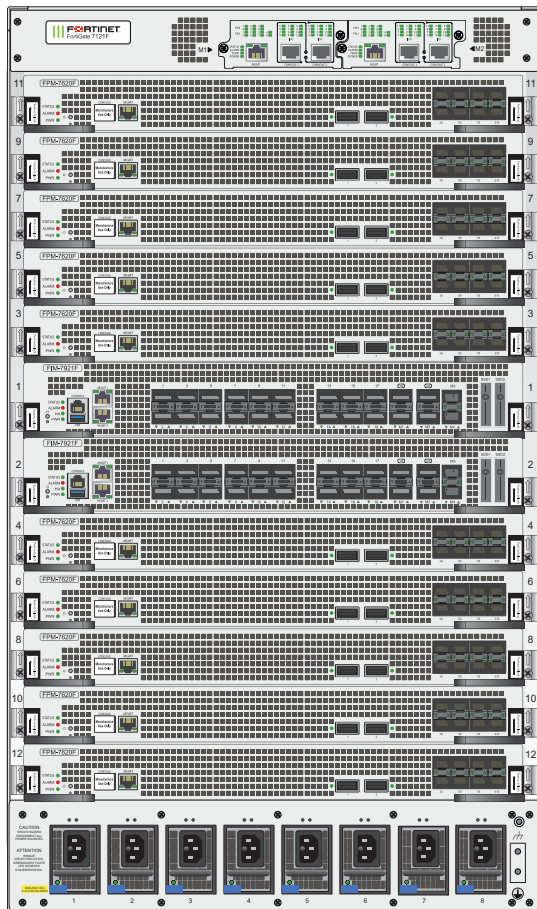

### Content Processor

Fortinet's ninth generation custom SPU CP9 content processor works outside of the direct flow of traffic and accelerates the inspection.

#### Powered by SPU

- Fortinet's custom SPU processors deliver the power you need to detect malicious content at multi-Gigabit speeds
- Other security technologies cannot protect against today's wide range of content- and connection-based threats because they rely on general-purpose CPUs, causing a dangerous performance gap
- SPU processors provide the performance needed to block emerging threats, meet rigorous third-party certifications, and ensure that your network security solution does not become a network bottleneck



### Network Processor

Fortinet's new, breakthrough SPU NP7 network processor works inline with FortiOS functions delivering:

- Superior firewall performance for IPv4/IPv6, SCTP and multicast traffic with ultra-low latency
- VPN, CAPWAP, and IP tunnel acceleration
- Anomaly-based intrusion prevention, checksum offload, and packet defragmentation
- Traffic shaping and priority queuing

### Trusted Platform Module (TPM)

The FortiGate 7121F Series features a dedicated module that hardens physical networking appliances by generating, storing, and authenticating cryptographic keys. Hardware-based security mechanisms protect against malicious software and phishing attacks.



# HARDWARE

## Fortinet Interface Module FIM-7921F

Hardware Interfaces	FIM-7921F
Hardware Accelerated 400 GE QSFP-DD / 100 GE QSFP28 / 40 GE QSFP+ Slots	2
Hardware Accelerated 100 GE QSFP28 / 40 GE QSFP+ Slots	18
Hardware Accelerated 100 GE QSFP28 / 40 GE QSFP+ Management/HA Slots	2
Hardware Accelerated 25 GE SFP28 / 10 GE SFP+ SFP Management/HA Slots	2
GE RJ45 Management Ports	2
USB Ports	1
Console Ports	1
Onboard Storage	2 x 4 TB SSD
Included Transceivers	2 x 10 GE SFP+ SR
Dimensions and Power	
Height x Width x Length (inches)	2.08 x 17.11 x 18.56
Height x Width x Length (mm)	63 x 435 x 471.3
Weight	21.48 lbs (9.75 kg)
Power Consumption (Average / Maximum)	568 W / 597 W
Current (Maximum)	50A
Heat Dissipation (Average)	2,036 BTU/h
Operating Temperature	32–104°F (0–40°C)
Storage Temperature	-31–158°F (-35–70°C)
Humidity	10–90% non-condensing
Compliance	
Certifications	FCC, ICES, CE, RCM, VCCI, BSMI, UL/cUL, CB

## Fortinet Processor Module FPM-7620F

Hardware Interfaces	FPM-7620F
Hardware Accelerated 100 GE QSFP28 / 40 GE QSFP+ Slots	2
Hardware Accelerated 25 GE SFP28 / 10 GE SFP+ Slots	8
GE RJ45 Management Ports	1
Console Ports	1
Dimensions and Power	
Height x Width x Length (inches)	1.69 x 17.11 x 18.56
Height x Width x Length (mm)	43 x 435 x 471
Weight	16.19 lb. (7.35 kg)
Power Consumption (Average / Maximum)	675 W / 716 W
Current (Maximum)	60A
Heat Dissipation (Average)	2,442 BTU/h
Operating Temperature	32–104°F (0–40°C)
Storage Temperature	-13–158°F (-25–70°C)
Humidity	20–90% non-condensing
Compliance	
Certifications	FCC, ICES, CE, RCM, VCCI, BSMI, UL/cUL, CB

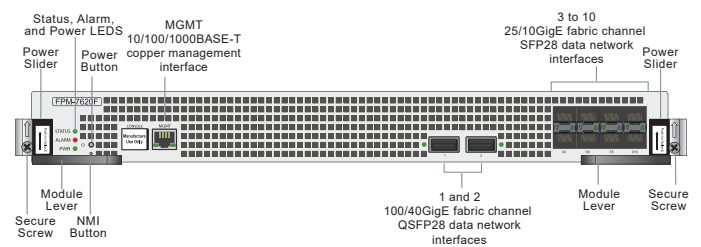
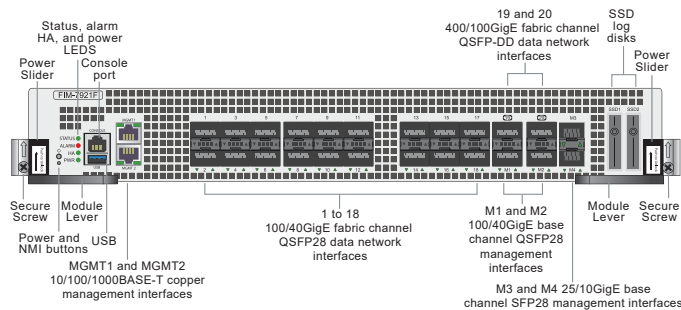

## Hardware Features

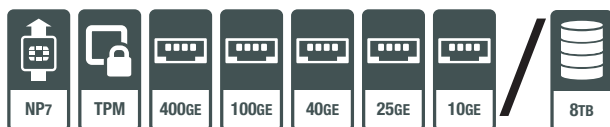

## Hardware Features

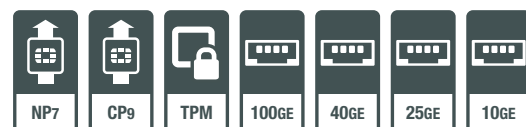

## SPECIFICATIONS

FG-7121F*	
<b>Interfaces and Modules</b>	
Hardware Accelerated 400 GE QSFP-DD / 100 GE QSFP28 / 40 GE QSFP+ Slots	4
Hardware Accelerated 100 GE QSFP28 / 40 GE QSFP+ Slots	56
Hardware Accelerated 100 GE QSFP28 / 40 GE QSFP+ Management/HA Slots	4
Hardware Accelerated 25 GE SFP28 / 10 GE SFP+ Slots	80
Hardware Accelerated 25 GE SFP28 / 10 GE SFP+ SFP Management/HA Slots	4
GE RJ45 Management Ports	4
USB Ports	2
Console Ports	14
Onboard Storage	4 × 4 TB SSD
Included Transceivers	4 × 10 GE SFP+ SR
<b>System Performance - Enterprise Traffic Mix</b>	
IPS Throughput <sup>2</sup>	675 Gbps
NGFW Throughput <sup>2,4</sup>	550 Gbps
Threat Protection Throughput <sup>2,5</sup>	520 Gbps
<b>System Performance and Capacity</b>	
Firewall Throughput (1518 / 512 / 64 byte, UDP packets)	1.89 / 1.88 / 1.129 Tbps
Firewall Latency (64 byte, UDP)	7.5 μs
Firewall Throughput (Packet per Second)	1,680 Mpps
Concurrent Sessions (TCP)	1 Billion
New Sessions/Sec (TCP)	9 Million
Firewall Policies	200,000
IPsec VPN Throughput (512 byte) <sup>6</sup>	630 Gbps
Gateway-to-Gateway IPsec VPN Tunnels	40,000
Client-to-Gateway IPsec VPN Tunnels	260,000
SSL-VPN Throughput <sup>7</sup>	13.7 Gbps
Concurrent SSL-VPN Users (Recommended Maximum)	30,000
IPS Throughput (Enterprise Mix) <sup>1</sup>	675 Gbps
SSL Inspection Throughput <sup>2</sup>	540 Gbps
SSL Inspection CPS (IPS, avg. HTTPS) <sup>3</sup>	480,000
SSL Inspection Concurrent Session (IPS, avg. HTTPS) <sup>3</sup>	100 Million
Application Control Throughput <sup>3</sup>	1.5 Tbps
NGFW Throughput <sup>4</sup>	550 Gbps
Threat Protection Throughput <sup>5</sup>	520 Gbps
CAPWAP Throughput	N.A.
Virtual Domains (Default / Maximum)	10 / 500
Maximum Number of FortiTokens	20,000
Maximum Number of FortiSwitches Supported	300
Maximum Number of FortiAPs (Total / Tunnel Mode)	N.A.
High Availability Configurations	Active-Passive, Active-Active

FG-7121F*	
<b>Dimensions and Power</b>	
Height x Width x Length (inches)	28.63 × 17.33 × 26.6
Height x Width x Length (mm)	727.2 × 440 × 675.5
Weight (maximum)	447.36 lbs (203.1 kg)
Form Factor (supports EIA/non-EIA standards)	16 RU 10 Slots for FPM and 2 Slots for FIM (default configuration 2xFPM-7620F and 2xFIM-7921F)
Power Required	200 to 240 VAC (50/60 Hz)
Power Consumption (Maximum / Average)	9754 W / 8296 W
AC Current (Maximum)	8 × 10A
Heat Dissipation (Maximum)	33,261 BTU/h
<b>Operating Environment and Certifications</b>	
Operating Temperature	32–104°F (0–40°C)
Storage Temperature	-31–158°F (-35–70°C)
Humidity	20–90% non-condensing
<b>Compliance</b>	
Certifications	FCC, ICES, CE, RCM, VCCI, BSMI, UL/cUL, CB

\* Performance specifications for FG-7121F are based on 10 FPM combination.

Note: All performance values are “up to” and vary depending on system configuration.

1. IPsec VPN performance test uses AES256-SHA256.
2. IPS (Enterprise Mix), Application Control, NGFW and Threat Protection are measured with Logging enabled.
3. SSL Inspection performance values use an average of HTTPS sessions of different cipher suites.

4. NGFW performance is measured with Firewall, IPS and Application Control enabled.
5. Threat Protection performance is measured with Firewall, IPS, Application Control, URL filtering, and Malware Protection with sandboxing enabled.
6. Measured with VPN load balancing.
7. Measured on single FPM only.



## ORDER INFORMATION

PRODUCT	SKU	DESCRIPTION
<b>FortiGate 7121F</b>	FG-7121F	16U 12-slot chassis with 2x FPM-7620F Processor Module, 2x FIM-7921F I/O Module , 2x Management Module and 8x hot swappable redundant PSU.
OPTIONAL / SPARE ITEMS	SKU	DESCRIPTION
<b>Processor Module</b>		
<b>FPM-7620F Module</b>	FPM-7620F	Hot swappable processing module for 7xxxF series - FortiASIC NP7 and CP9 hardware accelerated. 2x QSFP28 and 8x SFP28 ports.
<b>I/O Module</b>		
<b>FIM-7921F Module*</b>	FIM-7921F	Hot swappable I/O module for 7xxxF series - FortiASIC NP7 hardware accelerated. 2x GE RJ45 Management ports, 2x QSFP-DD ports, 20x QSFP28 ports, 2x SFP28 ports. 2x 4TB local log storage.
<b>Transceivers</b>		
<b>40 GE QSFP+ Transceivers, Short Range</b>	FG-TRAN-QSFP+SR	40 GE QSFP+ transceivers, short range for all systems with QSFP+ slots.
<b>40 GE QSFP+ Transceivers, Long Range</b>	FG-TRAN-QSFP+LR	40 GE QSFP+ transceivers, long range for all systems with QSFP+ slots.
<b>10 GE SFP+ Transceiver Module, Short Range</b>	FG-TRAN-SFP+SR	10 GE SFP+ transceiver module, short range for all systems with SFP+ and SFP/SFP+ slots.
<b>10 GE SFP+ Transceiver Module, Long Range</b>	FG-TRAN-SFP+LR	10 GE SFP+ transceiver module, long range for all systems with SFP+ and SFP/SFP+ slots.
<b>10 GE Copper SFP+ Transceiver Module, up to 30m</b>	FS-TRAN-SFP+GC	10 GE copper SFP+ RJ45 transceiver. For FortiSwitch only, up to 30m.
<b>100 GE QSFP28 Transceivers, 4 Channel Parallel Fiber, Short Range</b>	FG-TRAN-QSFP28-SR4	100 GE QSFP28 transceivers, 4 channel parallel fiber, short range for all systems with QSFP28 slots.
<b>100 GE QSFP28 Transceivers, 4 Channel Parallel Fiber, Long Range</b>	FG-TRAN-QSFP28-LR4	100 GE QSFP28 transceivers, 4 channel parallel fiber, long range for all systems with QSFP28 slots.

\* Each FIM is packed individually and comes with 2x 10 GE SFP+ SR transceivers at no charge.

NOTE: All optional/spare components are for replacement usage and should not be used to assemble a bundle as only bundles have the necessary subscriptions.

## BUNDLES



### FortiGuard Bundle

FortiGuard Labs delivers a number of security intelligence services to augment the FortiGate firewall platform. You can easily optimize the protection capabilities of your FortiGate with one of these FortiGuard Bundles.

Bundles	360 Protection	Enterprise Protection	Unified Threat Protection	Advanced Threat Protection
<b>FortiCare</b>	ASE <sup>1</sup>	24x7	24x7	24x7
<b>FortiGuard App Control Service</b>	•	•	•	•
<b>FortiGuard IPS Service</b>	•	•	•	•
<b>FortiGuard Advanced Malware Protection (AMP) — Antivirus, Mobile Malware, Botnet, CDR, Virus Outbreak Protection and FortiSandbox Cloud Service</b>	•	•	•	•
<b>FortiGuard Web and Video<sup>2</sup> Filtering Service</b>	•	•	•	
<b>FortiGuard Antispam Service</b>	•	•	•	
<b>FortiGuard Security Rating Service</b>	•	•		
<b>FortiGuard IoT Detection Service</b>	•	•		
<b>FortiGuard Industrial Service</b>	•	•		
<b>FortiConverter Service</b>	•	•		
<b>SD-WAN Orchestrator Entitlement</b>	•			
<b>SD-WAN Cloud Assisted Monitoring</b>	•			
<b>SD-WAN Overlay Controller VPN Service</b>	•			
<b>Fortinet SOCaS</b>	•			
<b>FortiAnalyzer Cloud</b>	•			
<b>FortiManager Cloud</b>	•			

1. 24x7 plus Advanced Services Ticket Handling    2. Available when running FortiOS 7.0



www.fortinet.com

Copyright © 2021 Fortinet, Inc. All rights reserved. Fortinet®, FortiGate®, FortiCare® and FortiGuard®, and certain other marks are registered trademarks of Fortinet, Inc., and other Fortinet names herein may also be registered and/or common law trademarks of Fortinet. All other product or company names may be trademarks of their respective owners. Performance and other metrics contained herein were attained in internal lab tests under ideal conditions, and actual performance and other results may vary. Network variables, different network environments and other conditions may affect performance results. Nothing herein represents any binding commitment by Fortinet, and Fortinet disclaims all warranties, whether express or implied, except to the extent Fortinet enters a binding written contract, signed by Fortinet's General Counsel, with a purchaser that expressly warrants that the identified product will perform according to certain expressly-identified performance metrics and, in such event, only the specific performance metrics expressly identified in such binding written contract shall be binding on Fortinet. For absolute clarity, any such warranty will be limited to performance in the same ideal conditions as in Fortinet's internal lab tests. Fortinet disclaims in full any covenants, representations, and guarantees pursuant hereto, whether express or implied. Fortinet reserves the right to change, modify, transfer, or otherwise revise this publication without notice, and the most current version of the publication shall be applicable.